

Article number: 0106039

Description: Retaining ring JV 22

## Measures

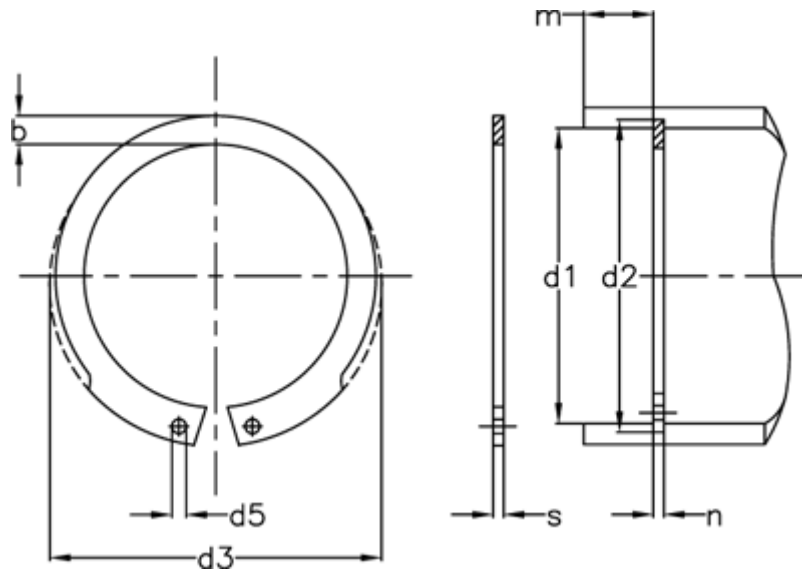

AN mm <sup>2</sup>	= 17	FRg kN	= 2.8	tol	= 0.1
b	= 2.4	FR kN	= 7.5	tol	= -0.06
d1	= 22	g	= 1.0	tol	= +0,42-0,13
d2	= 23.0	K kN-mm	= 17.8	tol	= +0,15
d3	= 23.5	m min	= 1.10	Tong	= ZGJ-1
d5 min	= 1.3	Nominal drive	= 1.8	Weight kg/1000	= 0.83
Description	= JV 22	s	= 1.00		
FN kN	= 2.80	t	= 0.50		